

Beck.

The adjustable pressure switches Prescal®.



Pressure switch 901 Prescal®

with adjustable setting

Application

Adjustable pressure switch monitoring overpressure, vacuum or differential pressure of liquid and gaseous – also aggressive – media.

The pressure switch uses a scaled adjustment knob to enable the adjustment of trip and reset pressure without the use of a screwdriver.

Temperature range

Ambient temperature from -20°C to 85°C .
Temperature of media from 85°C or 130°C depending on material of pressure connection and diaphragm.

Diaphragm material

Depending on media NBR, Silicone, FKM (Viton®), EPDM. For 901.8x Silicone, others upon request.

Electrical rating

Values indicated for resistive load

AgNi-contacts: 6 (1.5) A/250 VAC
2 A/24 VDC
Gold-plated contacts: 100 mA/24 VAC
30 mA/24 VDC

AgNi-contacts up to 10 A/250 VAC can be supplied upon request.

Electrical connection

AMP connection 6.3 mm x 0.8 mm DIN 46244.

Arrangement of contacts

for 901.6x, 901.8x,
901.9x

only for 901.7x

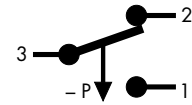
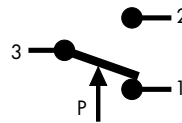

CE Conformity

each depending on technical specification: Low Voltage Directive 2006/95/EC; RoHS Directive 2011/65/EC; ATEX-Directive 94/9/EC; Gas Appliance Directive 90/396/EC (only for Type 901.61 to 901.65 with brass pressure connection).

Life

Minimum 10^6 cycles.

Damping

Restrictors alternatively with 0.3/0.5/0.8 mm diameter.

Accessories

Various mounting brackets and protection caps with IP 44, IP 54 and IP 65.

Mounting position

Mounting in any position, to be specified for settings below 100 mbar.

Pressure connection

Type	Tube connection			Threaded connection			
	5.0 mm	6.5 mm	10.0 mm	M 10 x1	G 1/8	G 1/4	G 1/2
901.61–65	PA	PA, PPS	PA, PPS	PA, PVDF CuZn40, V ₂ A	PA, PVDF CuZn40, V ₂ A	CuZn40, V ₂ A	CuZn40
901.66–68				CuZn40, V ₂ A	CuZn40, V ₂ A	CuZn40, V ₂ A	CuZn40
901.71–76	PA	PA, PPS	PA, PPS	PA, PVDF CuZn40, V ₂ A	PA, PVDF CuZn40, V ₂ A	CuZn40, V ₂ A	
901.77–78				CuZn40, V ₂ A	CuZn40, V ₂ A	CuZn40, V ₂ A	CuZn40
901.8x		PA					
901.91–93				CuZn40	CuZn40, V ₂ A	CuZn40, V ₂ A	

PA = polyamide, PVDF = polyvinylidendifluoride, PPS = polyphenylensulfide, CuZn40 = brass, V₂A = stainless steel

For temperature above 85°C metal or PPS pressure connection is required. Upon request pressure connections of other sizes, other plastics or brass nickel-plated are available.

Viton® is a registered trademark of DuPont Dow Elastomers.
Prescal® is a registered trademark of Beck GmbH Druckkontrolltechnik.



Overpressure range

Type	Adjustment range for trip pressure		Tolerance band in % of	Switching differential	Maximum positive working pressure standard/extended	Maximum negative working pressure standard/extended
	from	to				
901.61	5	20 mbar	± 10 %	3 mbar	0.5/4 bar	-/-1 bar
901.62	10	50 mbar	± 10 %	5 mbar	0.5/4 bar	-/-1 bar
901.63	25	100 mbar	± 10 %	10 mbar	0.5/4 bar	-/-1 bar
901.64	50	250 mbar	± 10 %	20 mbar	1/4 bar	-/-1 bar
901.65	100	500 mbar	± 10 %	50 mbar	1/4 bar	-/-1 bar
901.66	250	1.000 mbar	± 10 %	150 mbar	10 bar	-1 bar
901.67	500	1.500 mbar	± 10 %	250 mbar	10 bar	-1 bar
901.68	1.000	3.000 mbar	± 10 %	500 mbar	10 bar	-1 bar
901.91	1.0	6.0 bar	± 10 %	0.5 – 2.0 bar	25 bar	-1 bar
901.92	4.0	9.0 bar	± 10 %	0.5 – 2.0 bar	25 bar	-1 bar
901.93	7.0	12.0 bar	± 10 %	0.5 – 2.0 bar	25 bar	-1 bar

Vacuum range

901.71	-5	-20 mbar	± 10 %	3 mbar	0.5/4 bar	-1 bar
901.72	-10	-50 mbar	± 10 %	5 mbar	0.5/4 bar	-1 bar
901.73	-25	-100 mbar	± 10 %	10 mbar	0.5/4 bar	-1 bar
901.74	-50	-125 mbar	± 10 %	20 mbar	0.5/4 bar	-1 bar
901.75	-75	-200 mbar	± 10 %	25 mbar	1/4 bar	-1 bar
901.76	-100	-300 mbar	± 10 %	30 mbar	1/4 bar	-1 bar
901.77	-200	-500 mbar	± 10 %	75 mbar	1/4 bar	-1 bar
901.78	-300	-700 mbar	± 10 %	75 mbar	1/4 bar	-1 bar

Differential pressure range

901.81	5	20 mbar	± 10 %	3 mbar	100 mbar	-100 mbar
901.82	10	50 mbar	± 10 %	5 mbar	100 mbar	-100 mbar

Pressure switch 901 Prescal®

with adjustable setting

901.6x/7x

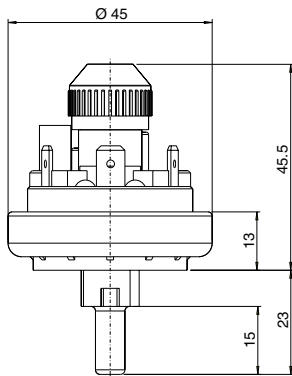

901.8x

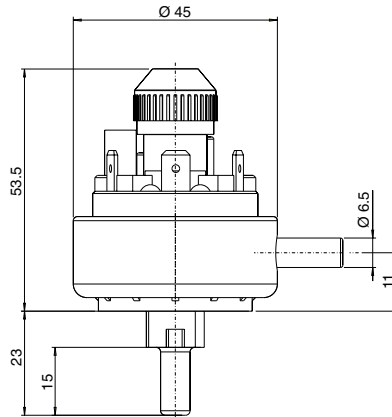

**Protection caps
6329 IP 44**

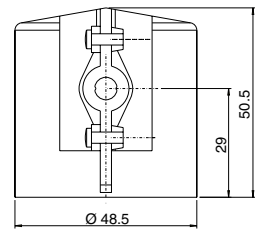

901.6x/7x

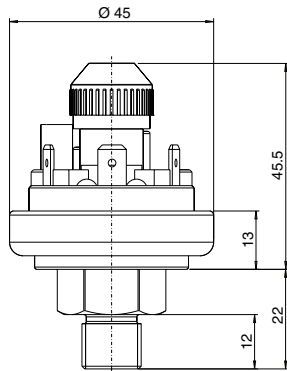

901.9x

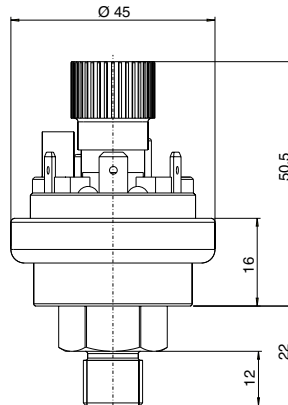

6365 IP 54

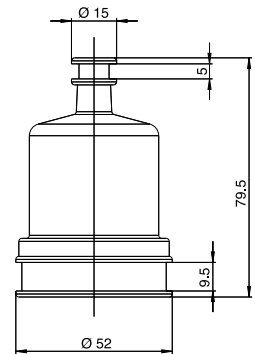

6371 IP 54 / 6372 IP 65

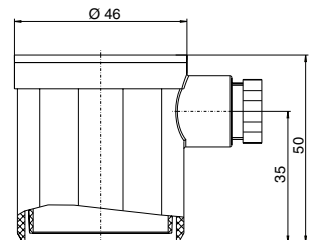

Mounting brackets

6403

6404

6405

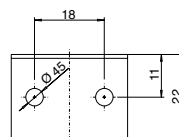
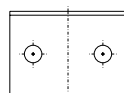
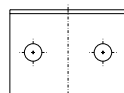
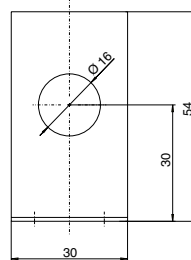
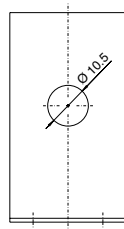
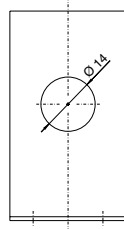
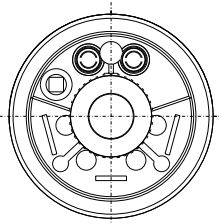

6374 IP 54 / 6375 IP 65

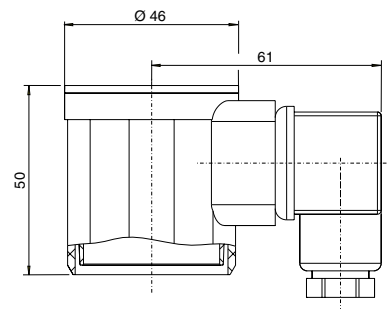

Beck GmbH
Druckkontrolltechnik
P.O. Box 11 31
D-71140 Steinenbronn

e-mail sales@beck-switch.com
<http://www.beck-switch.com>