

Beck.

The adjustable
pressure switches Prescal®
in Ex zones.



Pressure switch 901..Ex Prescal®

with adjustable switching pressure
for Ex zones 0, 1, 2 and 21, 22



Application

Adjustable pressure switch monitoring overpressure, vacuum or differential pressure of liquid and gaseous – also aggressive – media.

The pressure switch uses a scaled adjustment knob to enable the adjustment of trip and reset pressure without the use of a screwdriver.

Specifications

Medium	air, (non-)combustible and aggressive gases and vapours
Temperature ranges: Medium and ambient temperature	-20° C to +85° C
Storage temperature	-40° C to +85° C
Trip pressure ranges: Overpressure	5 to 20 mbar (min. measuring range) 7 to 12 bar (max. measuring range)
Vacuum	-5 to -20 mbar (min. measuring range) -300 to -700 mbar (max. measuring range)
Differential pressure	5 to 20 mbar (min. measuring range) 10 to 50 mbar (max. measuring range)
Max. working overpressure	0.2 to 25 bar/-1 bar (refer to table)
Switching differential	3 to 2,000 mbar; depending on pressure range (refer to table)
Trip pressure tolerance	±10% from setpoint
Materials:	
Tube connections	5 / 6.5 and 10 mm, PA / PPS
Threaded connections	M10x1 / G1/8 to G1/2 PA/PVDF/stainless steel/brass
Diaphragm	depending on medium; NBR, silicone, FKM (Viton®), EPDM, for 901.8x silicone (other materials on request).
Weight	30 to 300 g (depending on housing material)
Electrical rating	24 VDC/100 mA; 30 VDC/45 mA
Electrical connection	AMP flat plug, 6.3 mm x 0.8 mm, acc. to DIN 46244, or push-on screw terminals
Cable conduit	M16x1.5, with integrated cable strain relief
Protection category	IP 54 (with cover 6371)
Mechanical working life	over 10 ⁶ switching operations
Reducing nozzles	diameter optionally 0.3/0.5/0.8 mm

ATEX

EC type examination	BVS 06 ATEX E 141X
Device category	II 1/2G or II 2G and II 2D
Ignition protection type	Ex ia IIB T4 Ga/Gb or Ex ia IIC T4 Gb Ex ia IIIB T135C Db
CE conformity	ATEX Directive 94/9/EC RoHS-Directive 2011/65/EC EC Gas Device Directive 90/396/EC
Other approvals	type examination by TÜV Südwest and DVGW

Ex i-circuits

This pressure switch can be used in potentially explosive zones for gas in zones 0, 1, 2 and for dust in zones 21, 22. In the safe area, an associated isolating means (separating barrier, switching amplifier) must be connected before. The entire isolating circuit must then be proved to keep inherent safety. For this purpose, the power specifications (P, I, U) of the barrier must be lower and the characteristics (L, C) higher than those of the pressure switch and of the connection line (blue colour).

Characteristics:	
Gas for IIB,C:	30VDC /60mA; 24VDC/100mA
Dust for IIIB:	30VDC /60mA/0,6W
Capacitance - Ci	0 µF
Inductance - Li	0 mH

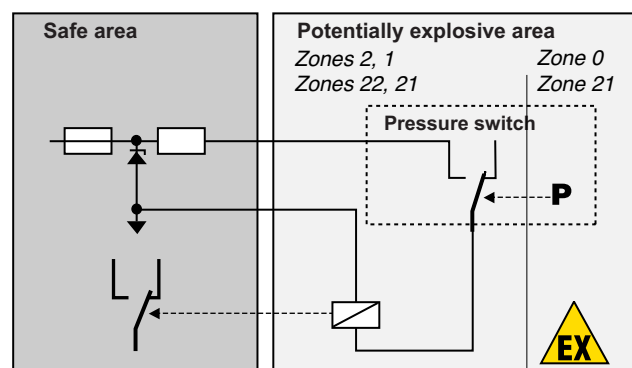

Arrangement of contacts

for 901.6x Ex, 901.8x Ex, 901.9x Ex

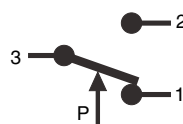

only for 901.7x Ex



Pressure connections

Type	Tube connections			Threaded connections			
	5.0 mm	6.5 mm	10.0 mm	M10 x1	G1/8	G1/4	G1/2
901.61-65 Ex	PA	PA, PPS	PA, PPS	PA, PVDF, MS, V ₂ A	PA, PVDF, MS, V ₂ A	MS, V ₂ A	MS
901.66-68 Ex				MS, V ₂ A	MS, V ₂ A	MS, V ₂ A	MS
901.71-76 Ex	PA	PA, PPS	PA, PPS	PA, PVDF, MS, V ₂ A	PA, PVDF, MS, V ₂ A	MS, V ₂ A	
901.77-78 Ex				MS, V ₂ A	MS, V ₂ A	MS, V ₂ A	MS
901.81 Ex		PA					
901.91-93 Ex				MS	MS, V ₂ A	MS, V ₂ A	

PPA = polyamide, PVDF = polyvinylidendifluoride, PPS = polyphenylensulfide, MS = brass

Overpressure ranges

Type	Setting range for		Reference scale accuracy	Switching differential	Maximum positive working pressure standard/extended	Maximum negative working pressure standard/extended
	between	and				
901.61 Ex	5	20 mbar	± 10 %	3 mbar	0.5/4 bar	-/-1 bar
901.62 Ex	10	50 mbar	± 10 %	5 mbar	0.5/4 bar	-/-1 bar
901.63 Ex	25	100 mbar	± 10 %	10 mbar	0.5/4 bar	-/-1 bar
901.64 Ex	50	250 mbar	± 10 %	20 mbar	1/4 bar	-/-1 bar
901.65 Ex	100	500 mbar	± 10 %	50 mbar	1/4 bar	-/-1 bar
901.66 Ex	250	1,000 mbar	± 10 %	150 mbar	10 bar	-1 bar
901.67 Ex	500	1,500 mbar	± 10 %	250 mbar	10 bar	-1 bar
901.68 Ex	1,000	3,000 mbar	± 10 %	500 mbar	10 bar	-1 bar
901.91 Ex	1.0	6.0 bar	± 10 %	0.5 – 2.0 bar	25 bar	-1 bar
901.92 Ex	4.0	9.0 bar	± 10 %	0.5 – 2.0 bar	25 bar	-1 bar
901.93 Ex	7.0	12.0 bar	± 10 %	0.5 – 2.0 bar	25 bar	-1 bar

Vacuum ranges

901.71 Ex	- 5	- 20 mbar	± 10 %	3 mbar	0.5/4 bar	-1 bar
901.72 Ex	- 10	- 50 mbar	± 10 %	5 mbar	0.5/4 bar	-1 bar
901.73 Ex	- 25	- 100 mbar	± 10 %	10 mbar	0.5/4 bar	-1 bar
901.74 Ex	- 50	- 125 mbar	± 10 %	20 mbar	0.5/4 bar	-1 bar
901.75 Ex	- 75	- 200 mbar	± 10 %	25 mbar	1/4 bar	-1 bar
901.76 Ex	- 100	- 300 mbar	± 10 %	30 mbar	1/4 bar	-1 bar
901.77 Ex	- 200	- 500 mbar	± 10 %	75 mbar	1/4 bar	-1 bar
901.78 Ex	- 300	- 700 mbar	± 10 %	75 mbar	1/4 bar	-1 bar

Differential pressure ranges

901.81 Ex	5	20 mbar	± 10 %	3 mbar	100 mbar	-100 mbar
901.82 Ex	10	50 mbar	± 10 %	5 mbar	100 mbar	-100 mbar



Pressure switch 901..Ex Prescal®

with adjustable switching pressure for Ex zones 0, 1, 2 and 21, 22

901.6x/7x

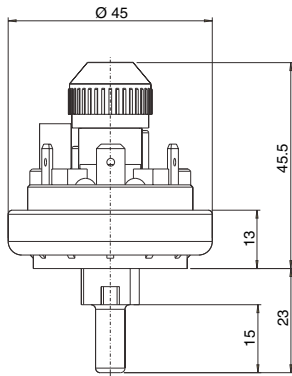

901.8x

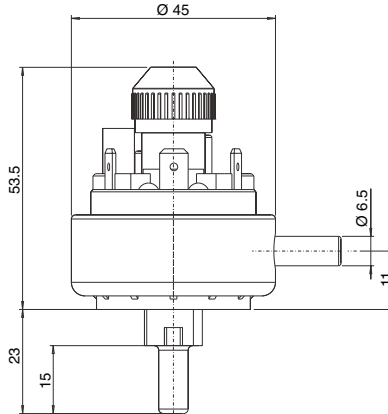

Covers
6371 IP 54 / 6372 IP 65

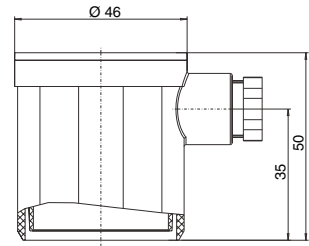

901.6x/7x

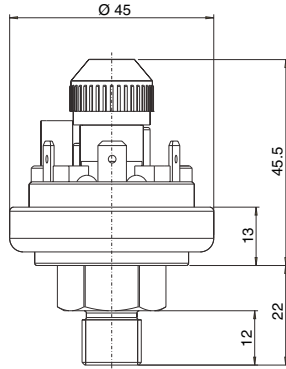

901.9x

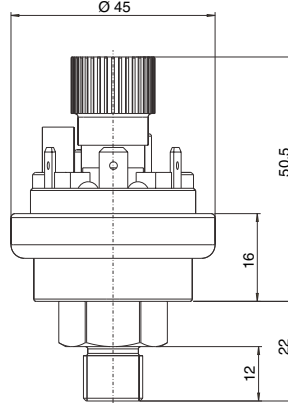

6374 IP 54 / 6375 IP 65

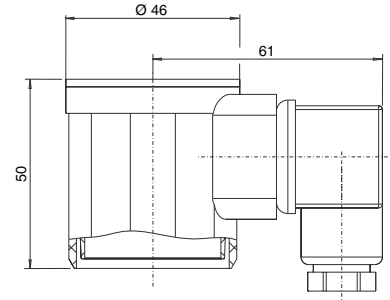

Mounting brackets
6403 6404 6405

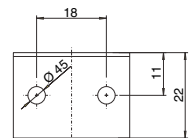
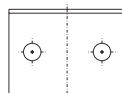
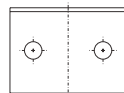
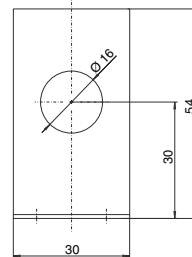
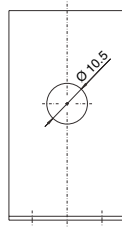
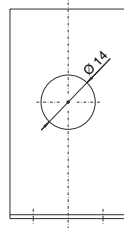
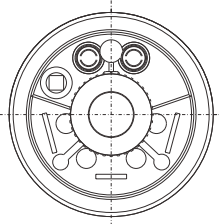

Viton® is a registered trademark of DuPont Dow Elastomers.
Prescal® is a registered trademark of Beck GmbH Druckkontrolltechnik.



Beck GmbH
Druckkontrolltechnik
P.O. Box 11 31
D-71140 Steinenbronn

e-mail sales@beck-switch.com
<http://www.beck-switch.com>