

## SiC SBD P3D06008T2

### 650V SiC Schottky Diode

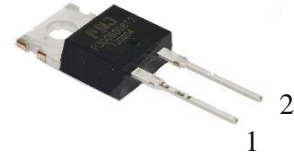

#### Features

- Qualified to AEC-Q101
- Ultra-Fast Switching
- Zero Reverse Recovery Current
- High-Frequency Operation
- Positive Temperature Coefficient on  $V_F$
- High Surge Current
- 100% UIS tested

TO-220-2

Cathode	1
Anode	2



#### Standards Benefits

- Improve System Efficiency
- Reduction of Heat Sink Requirement
- Essentially No Switching Losses
- Parallel Devices Without Thermal Runaway



#### Application

- Consumer SMPS
- Boost Diodes in PFC or DC/DC Stages
- AC/DC Converters



#### Order Information

Part Number	Package	Marking
P3D06008T2	TO-220-2	P3D06008T2



## Contents

Features.....	1
Standards Benefits .....	1
Application.....	1
Order Information .....	1
<b>Contents.....</b>	<b>2</b>
1. Maximum Ratings.....	3
2. Thermal Characteristics.....	3
3. Electrical Characteristics .....	4
4. Typical Performance .....	5
5. Package Outlines.....	6

PN Junction Semiconductor

## 1. Maximum Ratings

At  $T_J = 25^\circ\text{C}$ , unless specified otherwise

Parameter	Symbol	Value	Unit	Test condition
Repetitive Peak Reverse Voltage	$V_{RRM}$	650	V	$T_C = 25^\circ\text{C}$
Surge Peak Reverse Voltage	$V_{RSM}$	650	V	$T_C = 25^\circ\text{C}$
DC Blocking Voltage	$V_R$	650	V	$T_C = 25^\circ\text{C}$
Forward Current	$I_F$	26	A	$T_C = 25^\circ\text{C}$
		13		$T_C = 125^\circ\text{C}$
		8		$T_C = 153^\circ\text{C}$
Repetitive Peak Forward Surge Current	$I_{FRM}$	45	A	$T_C = 25^\circ\text{C}, t_p = 10\text{ms}$
		22		$T_C = 125^\circ\text{C}, t_p = 10\text{ms}$
Non-Repetitive Forward Surge Current	$I_{FSM}$	60	A	$T_C = 25^\circ\text{C}, t_p = 10\text{ms}$
		52		$T_C = 125^\circ\text{C}, t_p = 10\text{ms}$
Non-Repetitive Forward Surge Current	$I_{F, MAX}$	456	A	$T_C = 25^\circ\text{C}, t_p = 10\mu\text{s}$
		432		$T_C = 125^\circ\text{C}, t_p = 10\mu\text{s}$
Power Dissipation	$P_{tot}$	109	W	$T_C = 25^\circ\text{C}$
Operating Junction and Storage Temperature	$T_J, T_{STG}$	-55 to +175	$^\circ\text{C}$	
TO-220 Mounting Torque M3 Screw	$T_{orq}$	1	Nm lbf-in	
		8.8		

## 2. Thermal Characteristics

Parameter	Symbol	Values	Unit
Thermal Resistance from Junction to Case	$R_{\theta JC}$	1.38	$^\circ\text{C}/\text{W}$

### 3. Electrical Characteristics

At  $T_J = 25^\circ\text{C}$ , unless specified otherwise

Parameter	Symbol	Values			Unit	Test condition
		Min.	Typ.	Max.		
Forward Voltage	$V_F$	/	1.39	1.6	V	$I_F = 8\text{A}, T_J = 25^\circ\text{C}$
			1.65	/		$I_F = 8\text{A}, T_J = 175^\circ\text{C}$
Reverse Current	$I_R$	/	10.2	36	$\mu\text{A}$	$V_R = 650\text{V}, T_J = 25^\circ\text{C}$
			301	/		$V_R = 650\text{V}, T_J = 175^\circ\text{C}$
Total Capacitance	C	/	346	/	pF	$V_R = 0\text{V}, T_J = 25^\circ\text{C}$ $f = 1\text{MHz}$
			39			$V_R = 200\text{V}, T_J = 25^\circ\text{C}$ $f = 1\text{MHz}$
			30			$V_R = 400\text{V}, T_J = 25^\circ\text{C}$ $f = 1\text{MHz}$
Total Capacitive Charge	$Q_C$	/	19.6	/	nC	$V_R = 400\text{V}, I_F = 8\text{A}$ $T_J = 25^\circ\text{C}$
Capacitance Stored Energy	$E_C$	/	2.42	/	$\mu\text{J}$	$V_R = 400\text{V}$

## 4. Typical Performance

At  $T_J = 25^\circ\text{C}$ , unless specified otherwise

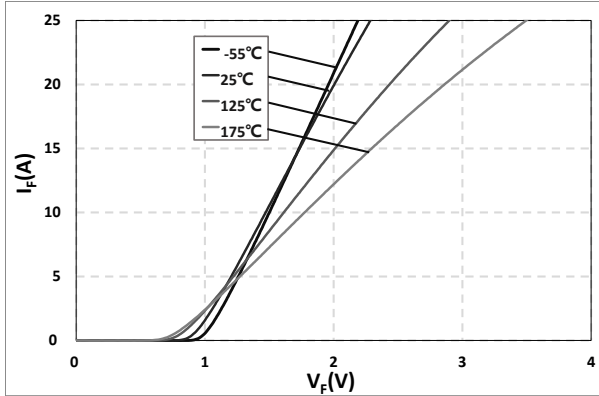

Fig. 1 Typical Forward Characteristics  
 $I_F = f(V_F)$ ;  $T_J = -55^\circ\text{C}, 25^\circ\text{C}, 125^\circ\text{C}, 175^\circ\text{C}$

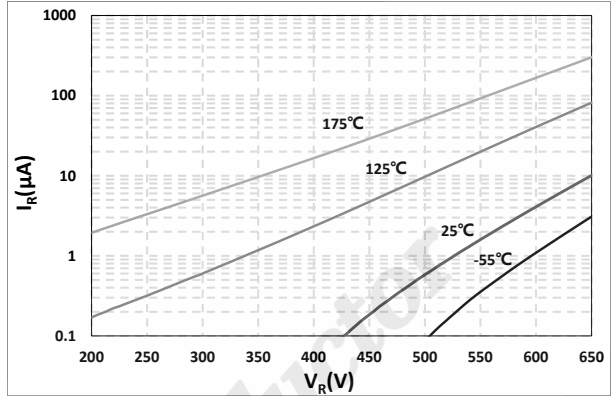

Fig. 2 Reverse Characteristics  
 $I_R = f(V_R)$ ;  $T_J = -55^\circ\text{C}, 25^\circ\text{C}, 125^\circ\text{C}, 175^\circ\text{C}$

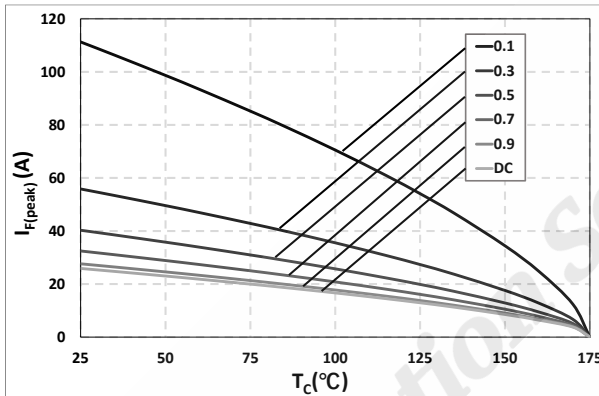

Fig. 3 Current Derating

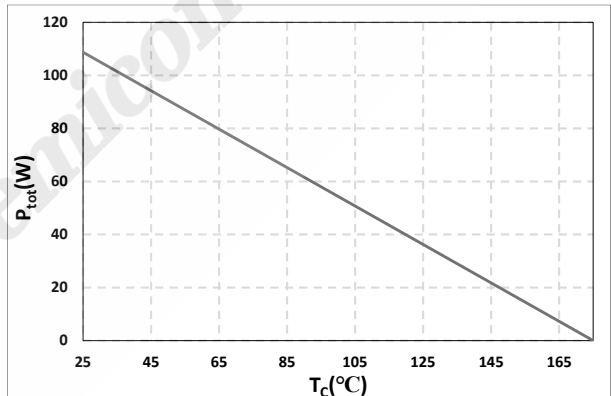

Fig. 4 Typical Power Derating  
 $P_{tot} = f(T_C)$

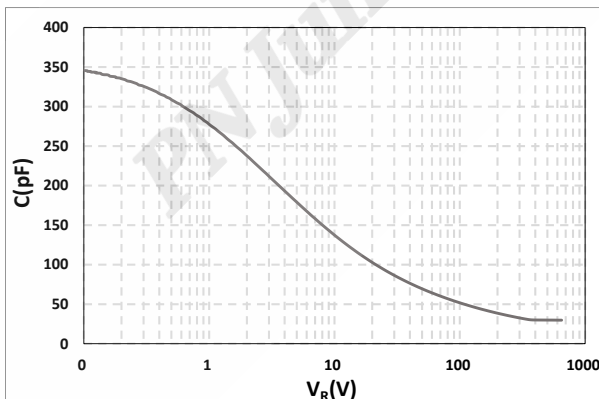

Fig. 5 Typical Total Capacitance  
 $C = f(V_R)$

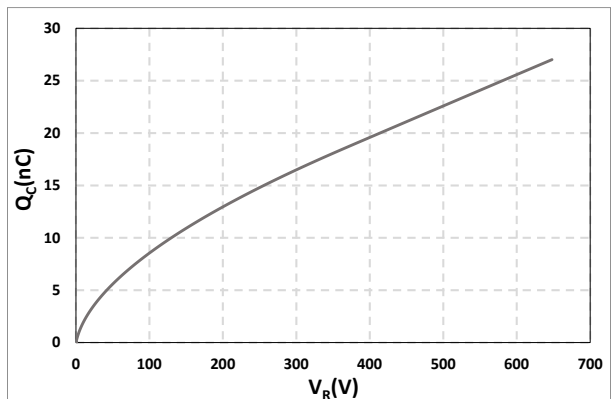

Fig. 6 Typical Total Capacitive Charge  
 $Q_C = f(V_R)$

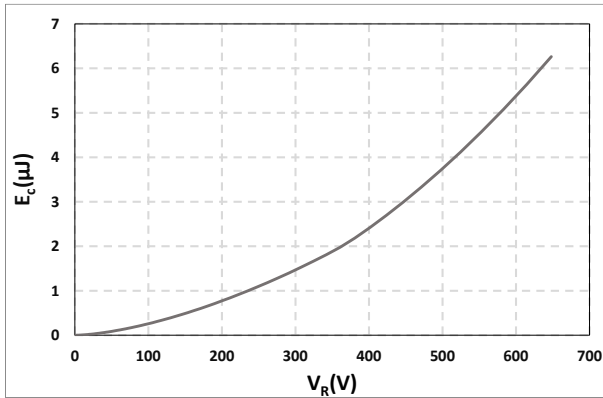

Figure 7. Capacitance Stored Energy  
 $E_C = f(V_R)$

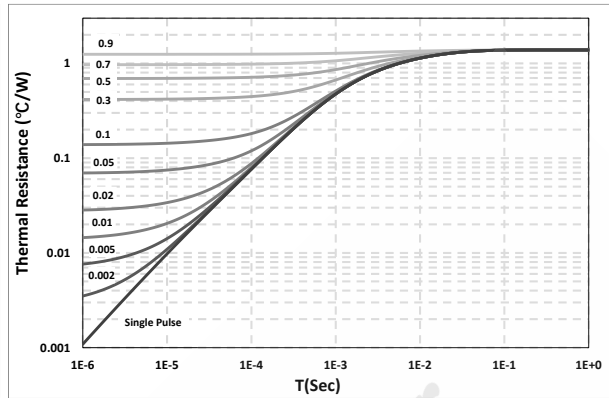
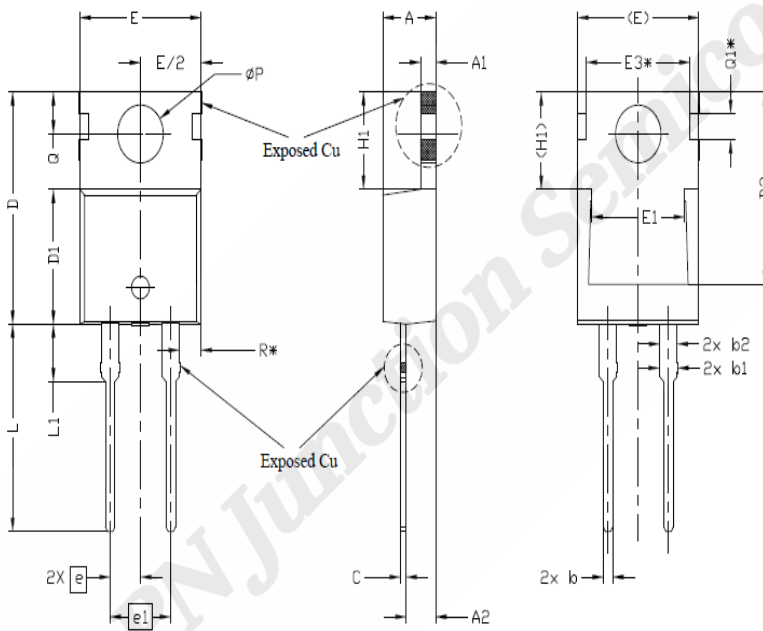

Figure 8. Transient Thermal Impedance

## 5. Package Outlines



SYMBOL	DIMENSIONS			NOTES
	MIN.	NOM.	MAX.	
A	4.24	4.44	4.64	
A1	1.15	1.27	1.40	
A2	2.30	2.48	2.70	
b	0.70	0.80	0.90	
b1	1.20	1.55	1.75	
b2	1.20	1.45	1.70	
c	0.40	0.50	0.60	
D	14.70	15.37	16.00	4
D1	8.82	8.92	9.02	
D2	12.63	12.73	12.83	5
E	9.96	10.16	10.36	4,5
E1	6.86	7.77	8.89	5
E3*	8.70REF.			
e	2.54BSC			
e1	5.08BSC			
H1	6.30	6.45	6.60	5,6
L	13.47	13.72	13.97	
L1	3.60	3.80	4.00	
φP	3.75	3.84	3.93	
Q	2.60	2.80	3.00	
Q1*	1.73REF.			
R*	1.82REF.			

Drawing and dimensions