

Report Number: MIC-ASI1931265

Audit Date : 14 Mar., 2020

This report is issued by Focus Technology Co., Ltd. (Made-in-China.com) and the supervising inspectorate (Bureau Veritas) to confirm that:

Company Name : HANGZHOU EMAX INDUSTRIAL CO., LTD.
杭州易迈斯实业有限公司

Showroom : <http://hzemaxmetal.en.made-in-china.com>

Address : **Office:** Room 1319, Building E, Hangzhou Bay Information Port, Hangzhou City, Zhejiang Province, China
Factory: No. 393, Fengsheng Industrial Zone, Guali Town, Xiaoshan District, Hangzhou City, Zhejiang Province, China

Product : Pole Line Hardware, Automotive Stamping Parts, Agriculture Machinery Parts

has been on site audited for the Following Scope of Activity

1. General Information
2. Foreign Trade Capacity
3. Product Research & Development Capacity
4. Production Capacity & Quality Control
5. Working Environment
6. Energy Saving and Emission Reduction
7. Photos



General Comments:

HANGZHOU EMAX INDUSTRIAL CO., LTD. is a manufacturer with 41 employees; It was established in 2016, located in Room 1319, Building E, Hangzhou Bay Information Port, Hangzhou City, Zhejiang Province, China and No. 393, Fengsheng Industrial Zone, Guali Town, Xiaoshan District, Hangzhou City, Zhejiang Province, China. The company occupies an area of 5077 square meters, and the main products are Pole Line Hardware, Automotive Stamping Parts, Agriculture Machinery Parts, and company has successful foreign trading experience in North America and Europe markets.



Sign for and on behalf of
Bureau Veritas

This document is issued by Bureau Veritas. Attention is drawn to the limitation of liability, indemnification and jurisdiction issues defined therein. Any holder of this document shall acknowledge that information contained hereon is solely limited to visual examination of the safety and readily accessible portions of consignment and does not constitute an endorsement of the product. The findings at the time of its intervention only and within the limits of Client's instructions, if any. The company's sole responsibility is to its Client. The company does not exonerate parties to a transaction from exercising all their rights and obligations under the transaction document. Any unauthorized alteration, forgery or falsification of the content or appearance of this document is unlawful and offenders may be prosecuted to the fullest extent of the law.

Attention: To check the authenticity of testing/inspection report & certificate, please click: <http://www.bvcerchina.cn/>



SUPPLIER ASSESSMENT REPORT

| | |
|-----------------|--|
| Audited Company | HANGZHOU EMAX INDUSTRIAL CO., LTD. 杭州易迈斯实业有限公司 |
| Audited Site: | Office: Room 1319, Building E, Hangzhou Bay Information Port, Hangzhou City, Zhejiang Province, China Factory: No. 393, Fengsheng Industrial Zone, Guali Town, Xiaoshan District, Hangzhou City, Zhejiang Province, China |

| | | | |
|-------------------------|--|---------------|--|
| Consigner of Assessment | Made-in-China.com | |  |
| Audit Type | <input checked="" type="checkbox"/> Initial Audit <input type="checkbox"/> Re-audit | | |
| Audit Date | 14 Mar., 2020 | Verify Report | |
| Auditor | Vance Wang | Reviewed by | Rosy Cheng |

CONTENTS

- Part A: General Information**
 - Section 1: Company Overview
 - Section 2: Human Resources
- Part B: Foreign Trade Capacity**
 - Section 1: Export Overall Situation
 - Section 2: Export Business Capacity
 - Section 3: Supplier Management
 - Section 4: After-sales Service Capacity
- Part C: Product Research & Development Capacity**
 - Section 1: Product Research & Development Capacity
- Part D: Management System and Product Certification**
 - Section 1: Management System(s) and Product Certification
- Part E: Production Capacity & Quality Control**
 - Section 1: Production Capacity Section
 - Section 2: Production Process Control
- Part F: Financial Position**
 - Section 1: Financial Data
 - Section 2: Key Performance Indications
 - Section 3: Banking
 - Section 4: Product Insurance
- Part G: Working Environment**
 - Section 1: Working Environment
- Part H: Energy Saving and Emission Reduction**
 - Section 1: Environmental Management
 - Section 2: Water, Gas and Noise Control
- Part I: Industry Information**
 - Section 1: Industry Information
- Part J: Photos**
 - Section 1: Photos of Documents
 - Section 2: Photos of Company

This document is issued by Bureau Veritas. Attention is drawn to the limitation of liability, indemnification and jurisdiction issues defined therein. Any holder of this document shall be aware that information contained hereon is solely limited to visual examination of the safety and readily accessible portions of consignment and does not constitute a guarantee of the safety of the consignment. The findings at the time of its intervention only and within the limits of Client's instructions, if any. The company's sole responsibility is to its clients. Any unauthorized alteration, forgery or falsification of the content or appearance of this document is unlawful and offenders may be prosecuted to the fullest extent of the law.

Attention: To check the authenticity of testing/inspection report & certificate, please click: <http://www.bvcerchina.cn/>



Part A: General Information

Section 1: Company Overview

| 1.1 Legal Validity | | | |
|---|--|---------------------|--------------------|
| Does the company have a valid business license? | <input checked="" type="checkbox"/> Yes <input type="checkbox"/> No <input type="checkbox"/> Others | Registration Number | 91330109MA27Y77062 |
| Year of established | 15 Jul., 2016 | Valid Date | Long Term Valid |
| Registered address | Shencun Village, Daicun Town, Xiaoshan District, Hangzhou City, Zhejiang Province, China | | |
| Actual address | Office: Room 1319, Building E, Hangzhou Bay Information Port, Hangzhou City, Zhejiang Province, China Factory: No. 393, Fengsheng Industrial Zone, Guali Town, Xiaoshan District, Hangzhou City, Zhejiang Province, China | | |
| Does the company in abnormal operation status list of industrial and commercial bureau? | No | | |
| Registered capital | RMB 5800000 | | |
| Name of legal representative | Ms. Jie Li | | |
| Business scope | Industrial investment; distribution: steel products, hardware products, iron stamping parts, welding parts, metal structure parts, machinery, electrical equipment parts, metal tools, automobile stamping parts, trailer parts (traction device), electric bicycle, luggage, agricultural machinery parts, metal furniture parts, plastic products, sports equipment and accessories, mechanical parts, sanitary ware Import and export of goods and technology;)(for projects subject to approval according to law, business activities can be carried out only after approval by relevant departments) Remark: excluding production. | | |
| 1.2 Basic Information | | | |
| Contact person | Mr. Peter Zhang | | |
| Phone number | 0086-15057111391, 0086-571-83737375 | Fax number | 0086-571-82588378 |
| URL/Web address | http://hzemaxmetal.en.made-in-china.com | | |
| Company type | <input type="checkbox"/> Manufacturer <input type="checkbox"/> Trading Company <input checked="" type="checkbox"/> Combined <input type="checkbox"/> Group Corporation | | |
| Type of ownership | <input checked="" type="checkbox"/> Limited Company <input type="checkbox"/> Public Company <input type="checkbox"/> Foreign joint venture <input type="checkbox"/> State-Owned <input type="checkbox"/> Private Owner <input type="checkbox"/> Wholly foreign-owned enterprises | | |
| Associated company | No associated company | | |
| Products manufactured / sold scope | Pole Line Hardware, Automotive Stamping Parts, Agriculture Machinery Parts | | |

This document is prepared by Bureau Veritas. Attention is drawn to the limitation of liability, indemnification and jurisdiction issues defined therein. Any holder of this document shall be aware that information contained hereon is solely limited to visual examination of the safety and readily accessible portions of consignment and does not constitute a warranty. The findings at the time of its intervention only and within the limits of Client's instructions, if any. The company's sole responsibility is to its clients. Bureau Veritas does not exonerate parties to a transaction from exercising all their rights and obligations under the transaction document. Any unauthorized alteration, forgery or falsification of the content or appearance of this document is unlawful and offenders may be prosecuted to the fullest extent of the law.

Attention: To check the authenticity of testing/inspection report & certificate, please click: <http://www.bvcerchina.cn/>





1.3 Company Building Information

According to:

- Land certificate Real estate certificate
 Lease agreement Observation Estimated on site

The company area 5077 square meters

The land occupies Nil square meters.

The offices occupy 77 square meters.

The workshops occupy 5000 square meters.

This document is prepared by Bureau Veritas. Attention is drawn to the limitation of liability, indemnification and jurisdiction issues defined therein. Any holder of this document shall acknowledge that information contained hereon is solely limited to visual examination of the safety and readily accessible portions of consignment and does not constitute a warranty. Bureau Veritas findings at the time of its intervention only and within the limits of Client's instructions, if any. The company's sole responsibility is to its clients. Bureau Veritas does not exonerate parties to a transaction from exercising all their rights and obligations under the transaction document. Any unauthorized alteration, forgery or falsification of the content or appearance of this document is unlawful and offenders may be prosecuted to the fullest extent of the law.

Attention: To check the authenticity of testing/inspection report & certificate, please click: <http://www.bvcerchina.cn/>



Section 2: Human Resources

2.1 Company Chart

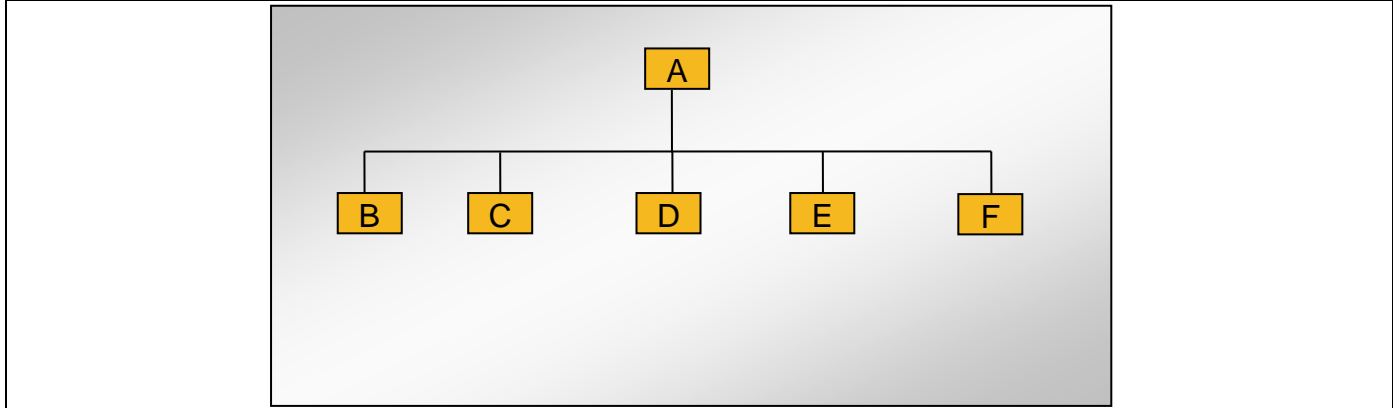

2.2 Explanation of Code and Employee Details

| Code | Department | Number of employees |
|-------------------------|-------------------------------------|---------------------|
| A | General Manager | 1 |
| B | Sales Department | 5 |
| C | Production Department | 30 |
| D | Financial Department | 1 |
| E | QC Department | 1 |
| F | Research and Development Department | 3 |
| Number in total: | | 41 |

2.3 Key Staff

| Title | Full name | Education | Working experience for this trade / total experience |
|---------------|-----------------|------------|--|
| Sales Manager | Mr. Peter Zhang | University | 12 Years /12 Years |

Remark: Above information of key staff was based on interview with company representative.



Part B: Foreign Trade Capacity

Section 1: Export Overall Situation

| 1.1 Export Overall Situation | |
|---|---|
| Does the company have a valid Import and Export license? | <input checked="" type="checkbox"/> Yes <input type="checkbox"/> No |
| The import and export enterprise code. | 91330109MA27Y77062 |
| The number of foreign trading staff with relevant trading experience. | <input type="checkbox"/> within 1 year staff <input checked="" type="checkbox"/> 1-5 years 3 staffs <input type="checkbox"/> 6-10 years staff <input checked="" type="checkbox"/> over 10 years 2 staffs Total 5 staffs |
| The language freely used by foreign trade staff | <input checked="" type="checkbox"/> English <input type="checkbox"/> others: |
| Annual revenue of previous year | RMB 16000000 |
| Annual export revenue of previous year | USD 2300000 |
| Estimated export revenue for this year. | RMB 30000000 |
| Overseas agent / branch | <input type="checkbox"/> Yes <input checked="" type="checkbox"/> No |
| Nearest port | Ningbo Port |
| Acceptable quotation terms | <input checked="" type="checkbox"/> FOB <input checked="" type="checkbox"/> CIF <input type="checkbox"/> CFR |
| Acceptable payment terms | <input checked="" type="checkbox"/> LC <input checked="" type="checkbox"/> T/T <input type="checkbox"/> D/P <input type="checkbox"/> PayPal <input type="checkbox"/> Western Union <input type="checkbox"/> Small-amount payment |
| Average lead time (Peak Season) | <input type="checkbox"/> within 15 workday <input checked="" type="checkbox"/> one month <input type="checkbox"/> 2-3 months <input type="checkbox"/> 4-6 months <input type="checkbox"/> 6-12 months <input type="checkbox"/> more time |
| Average lead time (Off Season) | <input type="checkbox"/> within 15 workday <input checked="" type="checkbox"/> one month <input type="checkbox"/> 2-3 months <input type="checkbox"/> 4-6 months <input type="checkbox"/> 6-12 months <input type="checkbox"/> more time |

Section 2: Export Business Capacity

| 2.1 Market Distribution (please list top three areas) | | |
|---|--|--------------|
| Market | Main Product | Main client |
| <input checked="" type="checkbox"/> North America | Pole Line Hardware, Automotive Stamping Parts, Agriculture Machinery Parts | Confidential |
| <input checked="" type="checkbox"/> Europe | Pole Line Hardware, Automotive Stamping Parts, Agriculture Machinery Parts | Confidential |

This document is prepared by Bureau Veritas. Attention is drawn to the limitation of liability, indemnification and jurisdiction issues defined therein. Any holder of this document shall be aware that information contained hereon is solely limited to visual examination of the safety and readily accessible portions of consignment and does not constitute a guarantee of the safety of the consignment. The findings at the time of its intervention only and within the limits of Client's instructions, if any. The company's sole responsibility is to its clients. Bureau Veritas does not exonerate parties to a transaction from exercising all their rights and obligations under the transaction document. Any unauthorized alteration, forgery or falsification of the content or appearance of this document is unlawful and offenders may be prosecuted to the fullest extent of the law.

Attention: To check the authenticity of testing/inspection report & certificate, please click: <http://www.bvcerchina.cn/>



Section 3: Supplier Management

| 3.1 Supplier Management | | |
|-------------------------|--|---|
| Item | Content | Observations /Comments |
| 1 | Does the company establish and implement an effective suppliers' assessment procedure? | <input type="checkbox"/> Have the written procedures and followed records <input type="checkbox"/> Have the written procedures but no records <input type="checkbox"/> Have relevant records without written procedure <input checked="" type="checkbox"/> No written procedures or followed records <input type="checkbox"/> Other |
| 2 | Does the company have an updated list of approved suppliers? | <input type="checkbox"/> The approved suppliers list was updated in _____ <input type="checkbox"/> Have the written suppliers without approved signature or date. <input checked="" type="checkbox"/> Provided some suppliers names <input type="checkbox"/> No approved suppliers list <input type="checkbox"/> Other |

Section 4: After-sales Service Capacity

| 4.1 After-sales Service Capacity | | |
|----------------------------------|--|--|
| Item | Content | Observations /Comments |
| 1 | Is there a procedure to conduct random product inspection after final packaging in place? | <input type="checkbox"/> Have clear standards and written inspection records <input checked="" type="checkbox"/> No written standards but had inspection reports <input type="checkbox"/> Have the procedures but no inspection records <input type="checkbox"/> It's not necessary to carry out the inspection <input type="checkbox"/> Other |
| 2 | Is there a clear procedure for handling customer complaints? | <input type="checkbox"/> Has the clear procedure and followed records <input type="checkbox"/> Has the procedure but no written records. <input checked="" type="checkbox"/> No written procedures or records. <input type="checkbox"/> Other |
| 3 | Can the finished/packaged product be traced by lot identification to the appropriate raw materials test reports? | <input type="checkbox"/> Have the procedures to trace the raw materials. <input checked="" type="checkbox"/> Can trace main materials <input type="checkbox"/> Can trace production date. <input type="checkbox"/> Can't trace products <input type="checkbox"/> Other |
| 4 | Are corrective & preventive actions mechanism established and implemented effectively (including the suppliers/ sub-contractors control, incoming inspection, process control, final inspection and customer complaint)? | <input type="checkbox"/> Has the clear procedure and followed records <input type="checkbox"/> Has the procedure but no written records. <input checked="" type="checkbox"/> No written procedures or records. <input type="checkbox"/> Other |

This document is prepared by Bureau Veritas. Attention is drawn to the limitation of liability, indemnification and jurisdiction issues defined therein. Any holder of this document shall understand that information contained hereon is solely limited to visual examination of the safety and readily accessible portions of consignment and does not constitute a warranty. The findings at the time of its intervention only and within the limits of Client's instructions, if any. The company's sole responsibility is to its Client. This document does not exonerate parties to a transaction from exercising all their rights and obligations under the transaction document. Any unauthorized alteration, forgery or falsification of the content or appearance of this document is unlawful and offenders may be prosecuted to the fullest extent of the law.

Attention: To check the authenticity of testing/inspection report & certificate, please click: <http://www.bvcerchina.cn/>



Part C: Product Research & Development Capacity

| 1.1 Product Research & Development Capacity | |
|--|---|
| The amount of R&D and relevant working experience. | <input type="checkbox"/> within 1 year staff <input type="checkbox"/> 1-5 years staff <input type="checkbox"/> 6-10 years staff <input checked="" type="checkbox"/> over 10 years 3 staff Total 3 engineers |
| What is the main job responsibility for R&D engineers? | Technology engineers were responsible for confirming customer's request, providing technical support for production and after-sales service. |
| Is there any relevant design input, output, review, verification and validation documentation available for auditor to review? | No. No information is provided on the scene |
| Is there any special software or instrument used by the R&D staffs during the design process of new products? If yes, please list the main software or instrument. | Yes. Auto CAD, Solidworks. |
| Does the company have an effective design change control procedure in place? | No. No information is provided on the scene |
| Please list the patent certificates and qualification license. | N/A |









This document is prepared by Bureau Veritas. Attention is drawn to the limitation of liability, indemnification and jurisdiction issues defined therein. Any holder of this document shall be aware that information contained hereon is solely limited to visual examination of the safety and readily accessible portions of consignment and does not constitute a warranty or any other form of assurance. The findings at the time of its intervention only and within the limits of Client's instructions, if any. The company's sole responsibility is to its Client. This document does not exonerate parties to a transaction from exercising all their rights and obligations under the transaction document. Any unauthorized alteration, forgery or falsification of the content or appearance of this document is unlawful and offenders may be prosecuted to the fullest extent of the law.

Attention: To check the authenticity of testing/inspection report & certificate, please click: <http://www.bvcerchina.cn/>

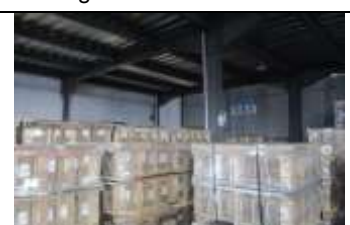

Part E: Production Capacity & Quality Control

Section 1: Production Capacity

| 1.1 Production Workflow Chart | | | | | |
|--|--------------|---|--------------------|---|---------------|
|  | → |  | → |  | → |
| Raw Materials | | Cutting | | Drilling | |
|  | → |  | → |  | → |
| Lathing | | Stamping | | Welding | |
|  | | | | | |
| Packing & Store | | | | | |
| 1.2 Products Situation (Top three Product Categories) | | | | | |
| Product | Price range | Min. order quantity | Top monthly output | Average monthly output | Total in 2019 |
|  Pole Line Hardware | Confidential | 100 PCS | Confidential | Confidential | Confidential |
|  Automotive Stamping Parts | Confidential | 100 PCS | Confidential | Confidential | Confidential |

This document is prepared by Bureau Veritas. Attention is drawn to the limitation of liability, indemnification and jurisdiction issues defined therein. Any holder of this document acknowledges that information contained hereon is solely limited to visual examination of the safety and readily accessible portions of consignment and does not constitute a warranty or any other form of assurance. The findings at the time of its intervention only and within the limits of Client's instructions, if any. The company's sole responsibility is to its Client. This document does not exonerate parties to a transaction from exercising all their rights and obligations under the transaction document. Any unauthorized alteration, forgery or falsification of the content or appearance of this document is unlawful and offenders may be prosecuted to the fullest extent of the law.

Attention: To check the authenticity of testing/inspection report & certificate, please click: <http://www.bvcerchina.cn/>



| | | | | | |
|--|--------------|---------|--------------|--------------|--------------|
|  Agriculture Machinery Parts | Confidential | 100 PCS | Confidential | Confidential | Confidential |
|--|--------------|---------|--------------|--------------|--------------|

1.3 Main Facilities

| Picture | Facility name | Brand or Country/Region of origin | Target Value/machine*day | Quantity |
|---|-------------------------|-----------------------------------|--------------------------|----------|
|  | Automatic Welding Robot | Japan | Confidential | 1 |
|  | Drilling Facility | China | Confidential | 5 |
|  | Lathing Facility | China | Confidential | 2 |
|  | Printing Facility | China | Confidential | 1 |
|  | Stamping Facility | China | Confidential | 70 |

This document is prepared by Bureau Veritas. Attention is drawn to the limitation of liability, indemnification and jurisdiction issues defined therein. Any holder of this document shall be aware that information contained hereon is solely limited to visual examination of the safety and readily accessible portions of consignment and does not constitute a warranty. The findings at the time of its intervention only and within the limits of Client's instructions, if any. The company's sole responsibility is to its Client. This document does not exonerate parties to a transaction from exercising all their rights and obligations under the transaction document. Any unauthorized alteration, forgery or falsification of the content or appearance of this document is unlawful and offenders may be prosecuted to the fullest extent of the law.

Attention: To check the authenticity of testing/inspection report & certificate, please click: <http://www.bvcerchina.cn/>



Section 2: Production Process Control

| 2.1 Production Process Control | | |
|--------------------------------|---|---|
| Item | Content | Observations /Comments |
| 1 | Product R&D capacity | <input type="checkbox"/> Own brand <input checked="" type="checkbox"/> ODM <input checked="" type="checkbox"/> OEM |
| 2 | Are the environmental conditions, such as tidiness and cleanliness being controlled and suitable for the operation performed? | <input type="checkbox"/> Very tidy <input checked="" type="checkbox"/> Normal <input type="checkbox"/> Need to improve <input type="checkbox"/> Very poor |
| 3 | Are the necessary items /documents provided at appropriate location and under control? | <input type="checkbox"/> Work Instructions /procedures <input type="checkbox"/> Workmanship standard /acceptance <input type="checkbox"/> Golden sample /Approval sample <input checked="" type="checkbox"/> Product picture <input type="checkbox"/> Verbal by workshop director |
| 4 | Are written instructions available for incoming material inspections /testing? Is the relevant record maintained? | <input type="checkbox"/> Has instructions and uniformly followed <input checked="" type="checkbox"/> Has instruction but no written records <input type="checkbox"/> Materials checked by storage staff |
| 5 | Are written inspections /testing instructions available for finished products? Is the relevant record maintained? | <input type="checkbox"/> Have instructions and uniformly followed <input checked="" type="checkbox"/> Have instruction but no written records <input type="checkbox"/> Finished product checked by packing staff |
| 6 | What type of inspection is used for finished products? | <input type="checkbox"/> Random inspection <input type="checkbox"/> Visual inspection <input type="checkbox"/> Function inspection <input checked="" type="checkbox"/> 100% inspection <input checked="" type="checkbox"/> Visual inspection <input checked="" type="checkbox"/> Function inspection |
| 7 | Are non-conforming units clearly marked/ segregated to prevent accidental dispatch? | <input type="checkbox"/> Marked and segregated <input checked="" type="checkbox"/> Segregated but not marked clearly <input type="checkbox"/> Not found on site |
| 8 | How are the non-conforming units handled? | <input type="checkbox"/> Repaired and re-inspection <input checked="" type="checkbox"/> Picked out <input type="checkbox"/> Used under control <input type="checkbox"/> Others |

This document is prepared by Bureau Veritas. Attention is drawn to the limitation of liability, indemnification and jurisdiction issues defined therein. Any holder of this document shall acknowledge that information contained hereon is solely limited to visual examination of the safety and readily accessible portions of consignment and does not constitute any findings at the time of its intervention only and within the limits of Client's instructions, if any. The company's sole responsibility is to its clients and it does not exonerate parties to a transaction from exercising all their rights and obligations under the transaction document. Any unauthorized alteration, forgery or falsification of the content or appearance of this document is unlawful and offenders may be prosecuted to the fullest extent of the law.

Attention: To check the authenticity of testing/inspection report & certificate, please click: <http://www.bvcerchina.cn/>



Part G: Working Environment

Section 1: Working Environment

| 1.1 Welfare Benefits | | |
|----------------------|---|---|
| Item | Content | Observations /Comments |
| 1 | Does the company have effective procedures to verify the age of staff at the time of recruitment? | <input checked="" type="checkbox"/> Has written procedure and keeps adequate age documents of workers <input type="checkbox"/> Has written procedure but doesn't follow records <input type="checkbox"/> Hasn't written procedure or follows records |
| 2 | Do all workers sign employment contracts with the factory? | <input checked="" type="checkbox"/> All workers sign employment contracts <input type="checkbox"/> Some workers sign employment contracts <input type="checkbox"/> Only management staff sign employment contracts <input type="checkbox"/> No staff sign employment contracts |
| 3 | Is statutory contribution required for all employees' social insurance (e.g. health insurance, unemployment insurance, accident insurance etc.) paid for by the enterprise? | <input checked="" type="checkbox"/> All workers have social insurance. <input type="checkbox"/> Some workers have social insurance <input type="checkbox"/> Only management staffs have social insurance <input type="checkbox"/> No staff have social insurance |
| 4 | Does the company have a clear and effective policy on working hours, rest and vacations? If does, please list it. | <input checked="" type="checkbox"/> All staffs work kept to the policy <input type="checkbox"/> Most of the time it keeps to the policy except midseason. <input type="checkbox"/> Usually needs overtime. <input type="checkbox"/> No relevant records for working hours Describe the working hours: 9: 00-12: 00, 13: 00-17: 00 |
| 5 | Does the company pay extra remunerations for all overtime work? | <input checked="" type="checkbox"/> For all overtime work. <input checked="" type="checkbox"/> For official holidays <input type="checkbox"/> For official holidays except weekend. <input type="checkbox"/> No extra remunerations for overtime. |
| 6 | Does the company have dormitories for staff? If yes, please describe the condition. | <input type="checkbox"/> Provide dormitories for all staff <input type="checkbox"/> Provide dormitories for workers <input type="checkbox"/> Provide dormitories for management staff <input checked="" type="checkbox"/> No dormitories were provided. Describe the condition: No Employees Needed |
| 1.2 Labor Protection | | |
| Item | Content | Observations /Comments |
| 1 | Are there uniforms for all staff in company? | <input type="checkbox"/> Yes <input checked="" type="checkbox"/> No <input type="checkbox"/> Other |
| 2 | Is the emergency medical supplies enough and easily used in workshop? | <input checked="" type="checkbox"/> Yes <input type="checkbox"/> No <input type="checkbox"/> Other |
| 3 | Does the company arrange health and safety training for new workers? | <input checked="" type="checkbox"/> Yes <input type="checkbox"/> No <input type="checkbox"/> Other |
| 4 | Do the workers have the appropriate protective equipment during operation in workshop? Such as gloves, masks. | <input checked="" type="checkbox"/> Yes <input type="checkbox"/> No <input type="checkbox"/> Other |

This document is prepared by Bureau Veritas. Attention is drawn to the limitation of liability, indemnification and jurisdiction issues defined therein. Any holder of this document shall be aware that information contained hereon is solely limited to visual examination of the safety and readily accessible portions of consignment and does not constitute a guarantee of conformity. The findings at the time of its intervention only and within the limits of Client's instructions, if any. The company's sole responsibility is to its clients. Bureau Veritas does not exonerate parties to a transaction from exercising all their rights and obligations under the transaction document. Any unauthorized alteration, forgery or falsification of the content or appearance of this document is unlawful and offenders may be prosecuted to the fullest extent of the law.

Attention: To check the authenticity of testing/inspection report & certificate, please click: <http://www.bvcerchina.cn/>





| | | |
|---|---|--|
| 5 | Is there training needed and carried out for fire protection? | <input checked="" type="checkbox"/> Yes <input type="checkbox"/> No <input type="checkbox"/> Other |
|---|---|--|

This document is prepared by Bureau Veritas. Attention is drawn to the limitation of liability, indemnification and jurisdiction issues defined therein. Any holder of this document should be aware that information contained hereon is solely limited to visual examination of the safety and readily accessible portions of consignment and does not constitute a warranty. Findings at the time of its intervention only and within the limits of Client's instructions, if any. The company's sole responsibility is to its Client. Bureau Veritas does not exonerate parties to a transaction from exercising all their rights and obligations under the transaction document. Any unauthorized use, reproduction, alteration, or falsification of the content or appearance of this document is unlawful and offenders may be prosecuted to the fullest extent of the law.

Attention: To check the authenticity of testing/inspection report & certificate, please click: <http://www.bvcerchina.cn/>



Part H: Energy Saving and Emission Reduction

Section 1: Environmental Management

| 1.1 Environmental Management | | |
|------------------------------|---|---|
| Item | Content | Observations /Comments |
| 1 | Environmental Management System | <input type="checkbox"/> ISO 14001 Certificate <input type="checkbox"/> Cleaner production management <input checked="" type="checkbox"/> NIL |
| 2 | Environmental Impact Assessment | <input type="checkbox"/> The Report of Environmental impact assessment is approved by EPA . <input checked="" type="checkbox"/> NIL |
| 3 | Check and Acceptance of Completed Constructive Projects | <input type="checkbox"/> The Report Completed Constructive Projects Inspection and Acceptance is approved. <input checked="" type="checkbox"/> NIL |
| 4 | "Three Simultaneity" for Environmental protection | <input type="checkbox"/> The Report of "Three Simultaneity" for Environmental protection Inspection and Acceptance is available. <input checked="" type="checkbox"/> NIL |

Section 2: Water, Gas and Noise Control

| 2.1 Water, Gas and Noise Control | | |
|----------------------------------|--|---|
| Item | Content | Observations /Comments |
| 1 | Water-intaking | <input type="checkbox"/> Water-intaking license <input type="checkbox"/> No water-intaking license <input checked="" type="checkbox"/> No water taken from natural water body |
| 2 | Waste water | <input type="checkbox"/> Water-draining license or contract <input type="checkbox"/> Having carried out waste water treatment before draining <input type="checkbox"/> Having carried out waste water monitoring and the result of which being within the standard limit <input checked="" type="checkbox"/> No detail activities were found |
| 3 | Emission to air | <input type="checkbox"/> Air pollutant emission license <input type="checkbox"/> Having carried out air pollutant emission monitoring and the result of which being within the standard limit <input checked="" type="checkbox"/> No detail activities were found to reduce emission to air |
| 4 | Classification and Recycling for solid waste | <input type="checkbox"/> Having applied trash classification recycling <input type="checkbox"/> Having special warehouse for hazardous waste <input checked="" type="checkbox"/> No detail activities were found |
| 5 | Noise | <input type="checkbox"/> The company carried out noise monitoring and the result of which being within the standard limit one time per year <input checked="" type="checkbox"/> No detail activities were found |

This document is prepared by Bureau Veritas. Attention is drawn to the limitation of liability, indemnification and jurisdiction issues defined therein. Any holder of this document shall acknowledge that information contained hereon is solely limited to visual examination of the safety and readily accessible portions of consignment and does not constitute a warranty. The findings at the time of its intervention only and within the limits of Client's instructions, if any. The company's sole responsibility is to its client. This document does not exonerate parties to a transaction from exercising all their rights and obligations under the transaction document. Any unauthorized alteration, forgery or falsification of the content or appearance of this document is unlawful and offenders may be prosecuted to the fullest extent of the law.

Attention: To check the authenticity of testing/inspection report & certificate, please click: <http://www.bvcerchina.cn/>



Part J: Photos

Section 1: Photos of Documents

1.1 Photos of Documents

| | |
|---|---|
| <p>Description: Business License</p>  | <p>Description: Permit for Opening Bank Account</p>  |
| <p>Description: Export License</p>  | <p>Description: Customs Registration Certificate</p>  |

This document is prepared by Bureau Veritas. Attention is drawn to the limitation of liability, indemnification and jurisdiction issues defined therein. Any holder of this document shall acknowledge that information contained hereon is solely limited to visual examination of the safety and readily accessible portions of consignment and any findings at the time of its intervention only and within the limits of Client's instructions, if any. The company's sole responsibility is to its client. Any unauthorized alteration, modification or falsification of the content or appearance of this document is unlawful and offenders may be prosecuted to the fullest extent of the law.

Attention: To check the authenticity of testing/inspection report & certificate, please click: <http://www.bvcerchina.cn/>



Section 2: Photos of Company

2.1 Photos of Company and Product Sample

Description: Company Gate



Description: Office



Description: Workshop



Description: Workshop



Description: Product Sample



Description: Product Sample



This document is prepared by Bureau Veritas. Attention is drawn to the limitation of liability, indemnification and jurisdiction issues defined therein. Any holder of this document should be aware that information contained hereon is solely limited to visual examination of the safety and readily accessible portions of consignment and does not constitute a warranty or findings at the time of its intervention only and within the limits of Client's instructions, if any. The company's sole responsibility is to its clients. Any unauthorized alteration, forgery or falsification of the content or appearance of this document is unlawful and offenders may be prosecuted to the fullest extent of the law.

Attention: To ensure the authenticity of testing/inspection report & certificate, please click: <http://www.bvcerchina.cn/>



-- End of the Report --

This document is prepared by Bureau Veritas. Attention is drawn to the limitation of liability, indemnification and jurisdiction issues defined therein. Any holder of this document shall acknowledge that information contained hereon is solely limited to visual examination of the safety and readily accessible portions of consignment and does not constitute any findings at the time of its intervention only and within the limits of Client's instructions, if any. The company's sole responsibility is to its clients and it does not exonerate parties to a transaction from exercising all their rights and obligations under the transaction document. Any unauthorized alteration, forgery or falsification of the content or appearance of this document is unlawful and offenders may be prosecuted to the fullest extent of the law.

Attention: To check the authenticity of testing/inspection report & certificate, please click: <http://www.bvcerchina.cn/>

